



SKYLO

AIR SIDE ENTRY FILL VALVE



WARNING

We shall not be responsible or liable for any failure of, or damage to, this plumbing product caused by the use of chlorine/bleach cleaners or related products added to the tank water. Use of such products will void the warranty and may result in product failure, possibly causing property damage. Do not over tighten plastic nuts and always turn off water supply when installing / removing toilet cistern parts.

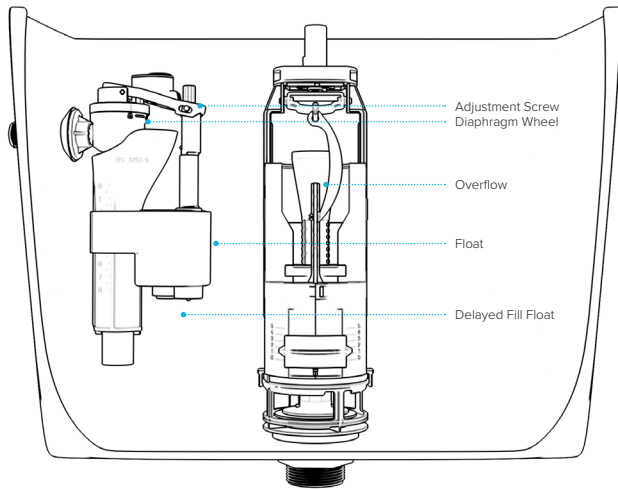

Please note: Save this instruction sheet for future reference
IMPORTANT: DO NOT use plumber's putty to seal this fitting

UK - Units 1-3 Capitol Trading Park, Kirkby Bank Road, Knowsley Industrial Estate, Liverpool, L33 7SY
EU - Authorised Rep Compliance Ltd., GroundFloor, 71 Lower Baggot Street, Dublin, D02 P593, Ireland.

For more information please contact us:
Tel: 0151 546 0531 E-mail: sales@vivasanitary.co.uk

INSTALLATION INSTRUCTIONS

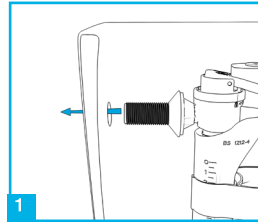

1 Place the valve in the correct position inside the cistern ensuring the conical rubber seal sits evenly inside the hole.

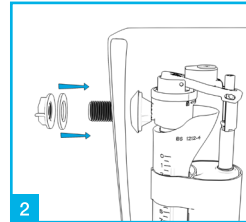

2 Secure the valve to the cistern using the plastic washer and nut. Do not over tighten.

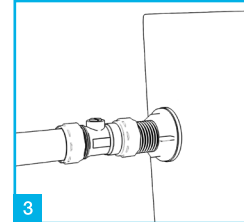

3 Connect the water supply to the fill valve and turn the water on checking for any leaks.

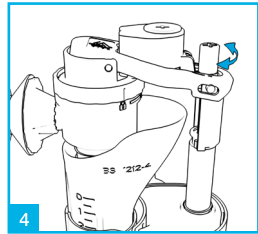

4 The water level can be adjusted by turning the adjustment screw (clockwise for more water, anticlockwise for less water).

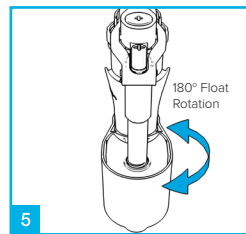

5 The valve has a float rotation system, allowing the float to be rotated 180. This is really beneficial if space is an issue.

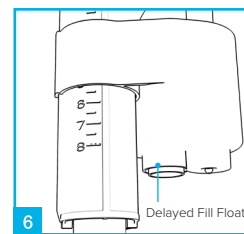

6 The valve comes with a delayed fill function which delays the filling of the cistern until the water is completely flushed.

TROUBLESHOOTING

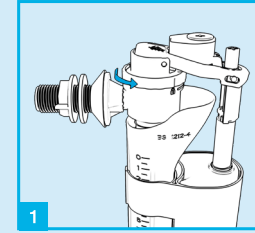

1 Turn off the water supply and set access wheel to unlock.

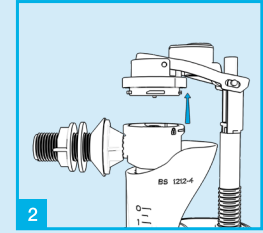

2 Lift the top assembly away from the valve holding the arm.

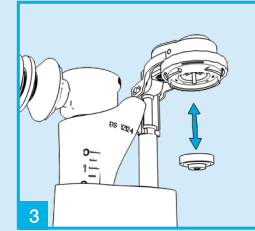

3 Remove diaphragm washer and clean with water or replace. Then, re-insert diaphragm washer.

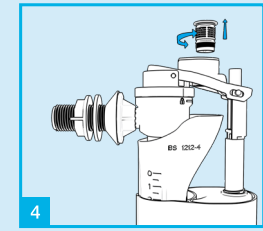

4 Remove aerator and clean with water.

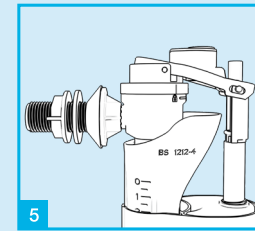

5 Refit top assembly complete with diaphragm.

Join Pro+ Installers club for exclusive benefits.

vivasanitary.co.uk/pro



Installation videos and further information available now.

