



SKYLO

BOTTOM ENTRY BALL VALVE



WARNING

We shall not be responsible or liable for any failure of, or damage to, this plumbing product caused by the use of chlorine/bleach cleaners or related products added to the tank water. Use of such products will void the warranty and may result in product failure, possibly causing property damage. Do not over tighten plastic nuts and always turn of water supply when installing / removing toilet cistern parts.

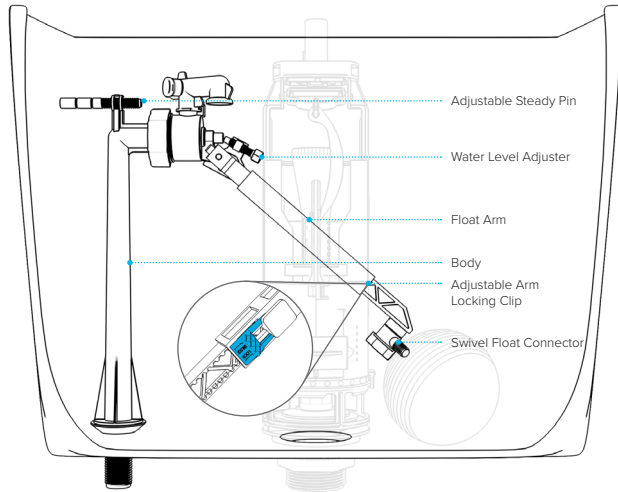

Please note: Save this instruction sheet for future reference
IMPORTANT: DO NOT use plumber's putty to seal this fitting

UK - Units 1-3 Capitol Trading Park, Kirkby Bank Road,
Knowsley Industrial Estate, Liverpool, L33 7SY
EU - Authorised Rep Compliance Ltd., GroundFloor,
71 Lower Baggot Street, Dublin, D02 P593, Ireland.

For more information please contact us:
Tel: 0151 546 0531 E-mail: sales@vivasanitary.co.uk

INSTALLATION INSTRUCTIONS

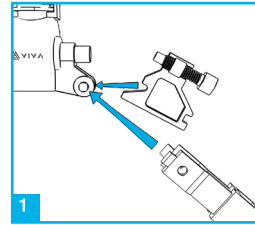

1 To assemble the valve, position the water level adjuster into place. Slide the adjustable arm over the water level adjuster and lock into the latches.

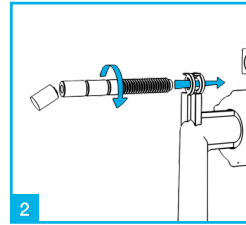

2 Screw the adjustable steady pin into top of upright stem, adjust length as required. It may also be necessary to shorten the pin.

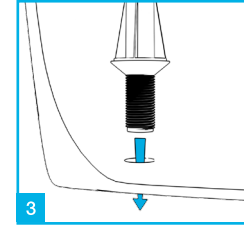

3 Remove the plastic washer and nut from the thread and position the valve in the cistern ensuring the conical rubber sits on the hole at the cistern base.

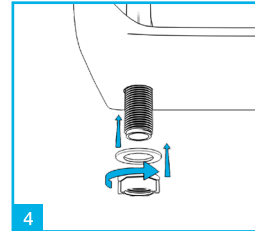

4 Secure valve to the cistern by replacing the plastic washer and screwing the nut to the thread. Do not over tighten.

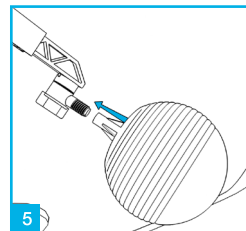

5 Fit suitable ball float to end of float arm. The position of the ball can be adjusted by loosening plastic wing nut, when desired position is achieved re-tighten wing nut.

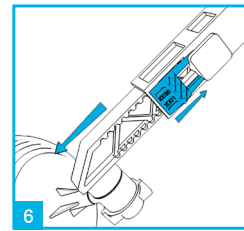

6 The arm length can also be adjusted by sliding the adjustment clip to unlock, move the arm in or out to desired length then lock the clip.

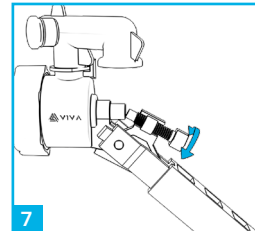

7 The water level can be adjusted by turning the adjustment screw (clockwise for less water, anticlockwise for more water).

TROUBLESHOOTING

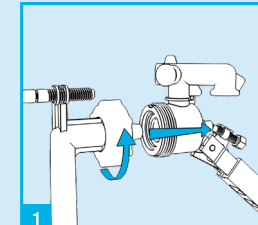

1 Ensure water is switched off and loosen the retaining nut. Remove the valve from the retaining nut.

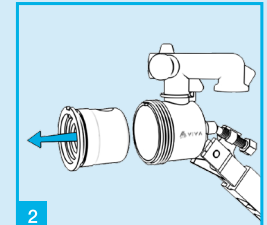

2 To access the diaphragm washer remove white plastic insert.

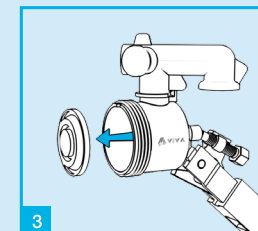

3 Remove the diaphragm washer and clean or replace.

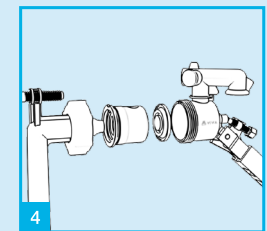

4 Re-assemble diaphragm and white insert.

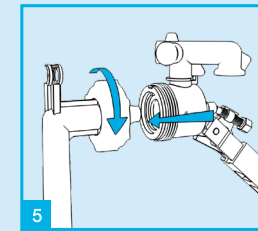

5 Re-connect valve.

Join Pro+ Installers club for exclusive benefits.

vivasanitary.co.uk/pro



Installation videos and further information available now.

